

 **HONDA**

**OWNER'S MANUAL
MANUAL DEL PROPIETARIO**



CRF80F

Honda CRF80F

OWNER'S MANUAL

MANUAL DEL PROPIETARIO

IMPORTANT INFORMATION

- **OPERATOR ONLY. NO PASSENGER**

This motorcycle is designed and constructed as an operator-only model. The seating configuration does not safely permit the carrying of a passenger. Do not exceed the maximum weight capacity.

- **FOR OFF-ROAD USE ONLY**

This motorcycle is designed and manufactured for off-road use only.

- **PARENTS : READ IMPORTANT MESSAGE ON PAGE 1 .**

- **READ THIS OWNER'S MANUAL CAREFULLY**

Pay special attention to the safety messages that appear throughout the manual. These messages are fully explained in the "A Few Words About Safety" section which appears before the Contents page.

This manual should be considered a permanent part of the motorcycle and should remain with the motorcycle when resold.

Honda CRF80F OWNER'S MANUAL

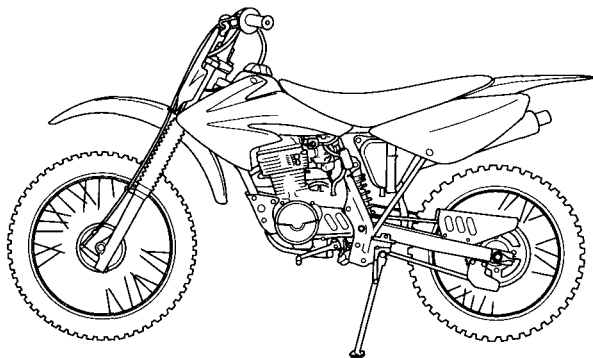

All information in this publication is based on the latest production information available at the time of approval for printing. Honda Motor Co.,Ltd. reserves the right to make changes at any time without notice and without incurring any obligation.

No part of this publication may be reproduced without written permission.

WELCOME

Your new motorcycle presents you with an invitation to adventure and a challenge to master the machine. Your safety depends not only on your own alertness and familiarity with the motorcycle, but also the motorcycle's mechanical condition. A pre-ride inspection before every outing and regular maintenance are essential.

To help meet the challenges safely and enjoy the adventure fully, become thoroughly familiar with this Owner's Manual **BEFORE YOU RIDE THE MOTORCYCLE**.

As you read this manual, you will find information that is preceded by a **NOTICE** symbol. This information is intended to help you avoid damage to your motorcycle, other property, or the environment.

When service is required, remember that your Honda dealer knows your motorcycle best. If you have the required mechanical "know-how" and tools, your dealer can supply you with an official Honda Shop Manual to help you perform many maintenance and repair tasks.

Pleasant riding, and thank you for choosing a Honda !

- The following codes in this manual indicate each country.

U	Australia	MX	Mexico
---	-----------	----	--------

- The specifications may vary with each locale.

▲ DANGER

You **WILL** be **KILLED** or **SERIOUSLY HURT** if you don't follow instructions.

▲ WARNING

You **CAN** be **KILLED** or **SERIOUSLY HURT** if you don't follow instructions.

▲ CAUTION

You **CAN** be **HURT** if you don't follow instructions.

- **Safety Headings** — such as Important Safety Reminders or Important Safety Precautions.
- **Safety Section** — such as Motorcycle Safety.
- **Instructions** — how to use this motorcycle correctly and safely.

This entire manual is filled with important safety information — please read it carefully.

A FEW WORDS ABOUT SAFETY

Your safety, and the safety of others, is very important. And operating this motorcycle safely is an important responsibility.

To help you make informed decisions about safety, we have provided operating procedures and other information on labels and in this manual. This information alerts you to potential hazards that could hurt you or others.

Of course, it is not practical or possible to warn you about all hazards associated with operating or maintaining a motorcycle. You must use your own good judgment.

You will find important safety information in a variety of forms, including:

- **Safety Labels** — on the motorcycle.
- **Safety Messages** — preceded by a safety alert symbol  and one of three signal words: **DANGER**, **WARNING**, or **CAUTION**.

These signal words mean:

OPERATION

page

- 1 MOTORCYCLE SAFETY**
- 1 IMPORTANT MESSAGE TO PARENTS
- 3 IMPORTANT SAFETY INFORMATION
- 5 PROTECTIVE APPAREL
- 7 LOAD LIMITS AND GUIDELINES

11 PARTS LOCATION

14 MAJOR COMPONENTS

(Information you need to operate this motorcycle)

- 14 BRAKES
- 19 CLUTCH
- 22 FUEL
- 26 ENGINE OIL
- 27 TYRES

page

- 32 ESSENTIAL INDIVIDUAL COMPONENTS**
- 32 IGNITION SWITCH
- 33 ENGINE STOP BUTTON

page

34 FEATURES

(Not required for operation)

34 SIDE COVER

page

35 OPERATION

35 PRE-RIDE INSPECTION

37 STARTING THE ENGINE

40 RUNNING-IN

41 RIDING

43 HIGH ALTITUDE RIDING
(Except Mexico)

43 LOW ALTITUDE RIDING
(Mexico only)

44 BRAKING

45 PARKING

45 ANTI-THEFT TIPS

MAINTENANCE

page

46 MAINTENANCE

- 46 THE IMPORTANCE OF MAINTENANCE
- 47 MAINTENANCE SAFETY
- 48 SAFETY PRECAUTIONS
- 49 MAINTENANCE SCHEDULE
- 52 TOOL KIT
- 53 SERIAL NUMBERS
- 54 COLOUR LABEL
- 55 AIR CLEANER
- 56 ENGINE OIL
- 61 SPARK PLUG
- 63 IDLE SPEED
- 64 THROTTLE OPERATION
- 66 SPARK ARRESTER
- 67 DRIVE CHAIN
- 72 WHEEL RIMS AND SPOKES
- 73 WHEEL REMOVAL
- 76 BRAKE SHOE WEAR
- 77 FRONT SUSPENSION
- 78 REAR SUSPENSION
- 79 SIDE STAND

page

80 CLEANING

83 STORAGE GUIDE

- 83 STORAGE
- 85 REMOVAL FROM STORAGE

86 SPECIFICATIONS

MOTORCYCLE SAFETY

IMPORTANT MESSAGE TO PARENTS

Your child's safety is very important to Honda. That's why we urge you to read this message before you let any young person ride this motorcycle. Off-road riding can be fun. But as with riding a bicycle, bad judgements can result in injuries, and we don't want that to happen! As a parent, you can help prevent accidents by making good decisions about if, when, and how your youngster rides this motorcycle.

Riding Readiness

The first decision you'll need to make is whether your youngster is ready to ride. Riding readiness varies widely from one person to another, and age and size are not the only factors.

PHYSICAL ABILITY is an important consideration. For example, riders must be big enough to hold the motorcycle up, get on, and comfortably sit on the seat with both feet touching the ground. They should also be able to easily reach and work the brakes, the throttle and all other controls.

ATHLETIC ABILITY is necessary for riding a motorcycle. Generally speaking, your youngster should be good at riding a bicycle before getting on a motorcycle. Can your youngster judge speeds and distances on a bicycle and react with proper hand and foot actions? Anyone who does not have good coordination, balance, and agility is not ready to ride this motorcycle.

MENTAL AND EMOTIONAL MATURITY are requirements for safe riding. Does your youngster think through problems and come to logical solutions? On a bicycle, does your youngster obey safe riding rules? Be honest! Young people who take unnecessary risks, make bad judgements and don't obey rules are not ready to ride this motorcycle.

Instruction and Supervision

If you decide that your youngster is ready to safely operate this motorcycle, make sure both of you carefully read and understand the Owner's Manual before riding. Also be sure that your youngster has a helmet and other appropriate riding equipment and always wears it when operating the vehicle or sitting on it.

GOOD INSTRUCTION is an important part of hands-on training. The teacher can either be you or another responsible adult who has experience with off-road motorcycle riding. (For help in finding a qualified instructor, talk with your Honda dealer.) Even if you're not the main teacher, it's up to you to ensure your youngster's safety. Remember, learning to ride a motorcycle is a gradual step-by-step process. It takes time, patience and practice — many hours over a period of weeks or months.

SUPERVISION is another important obligation of parents. Even after youngsters have become skilled off-road riders, they should always ride with adult supervision. It helps to regularly remind young riders of basic safety rules and cautions. And remember, it's your responsibility to see that the vehicle is properly maintained and kept in safe operating condition.

SAFE AND RESPONSIBLE RIDING must be an ongoing commitment — by you and your youngster. When you both put safety first, you can enjoy more peace of mind, and your youngster can enjoy more hours of safe off-road riding.

For your convenience, this CRF80F comes with an ignition switch and key. Remove the key when the motorcycle is parked to help prevent unauthorized use.

IMPORTANT SAFETY INFORMATION

Your motorcycle can provide many years of service and pleasure—if you take responsibility for your own safety and understand the challenges you can meet while riding.

This motorcycle has been designed for younger riders, as well as for smaller adults. However, not all youngsters are physically or emotionally ready to ride. Therefore, before parents allow any youngster to ride this motorcycle, we urge them to carefully read the Important Message to Parents on page 1 .

There is much that you can do to protect yourself when you ride. You'll find many helpful recommendations throughout this manual. Following are a few that we consider most important.

Always Wear a Helmet

It's a proven fact: helmets significantly reduce the number and severity of head injuries. So always wear an approved motorcycle helmet. We also recommend that you wear eye protection, sturdy boots, gloves and other protective gear (page 5).

Never Carry a Passenger

Your motorcycle is designed for one person only. There are no handholds, footrests, or seat for a second person—so never carry a passenger. A passenger could interfere with your ability to move around to maintain your balance and control of the motorcycle.

Ride Off-Road Only

Your motorcycle is designed and manufactured for off-road use only. The tyres are not made for pavement, and the motorcycle does not have turn signals and other features required for use on public roads. If you need to cross a paved or public road, get off and walk your motorcycle across.

Take Time to Learn and Practice

Developing off-road riding skills is a gradual, step-by-step process. Start by practicing at low speeds in a safe area and slowly build your skills. Personal instruction from an experienced rider can also be valuable.

If you need assistance, ask your dealer about riding groups in your area.

Be Alert for Off-Road Hazards

The terrain can present a variety of challenges when you ride off-road. Continually “read” the terrain for unexpected turns, drop-offs, rocks, ruts, and other hazards. Always keep your speed low enough to allow time to see and react to hazards.

Ride Within Your Limits

Pushing the limits is another major cause of motorcycle accidents. Never ride beyond your personal abilities or faster than conditions warrant. Remember that alcohol, drugs, fatigue and inattention can significantly reduce your ability to make good judgements and ride safely.

Don't Drink and Ride

Alcohol and riding don't mix. Even one drink can reduce your ability to respond to changing conditions, and your reaction time gets worse with every additional drink. So don't drink and ride, and don't let your friends drink and ride either.

Keep Your Bike in Safe Condition

For safe riding, it's important to inspect your motorcycle before every ride and perform all recommended maintenance. Never exceed load limits, and only use accessories that have been approved by Honda for this motorcycle. See page 7 for more details.

Others

- This motorcycle is not equipped with lights. Don't ride at night.

PROTECTIVE APPAREL

For your safety, we strongly recommend that you always wear an approved motorcycle helmet, eye protection, boots, gloves, long pants, and a long-sleeved jersey, shirt or jacket whenever you ride. Although complete protection is not possible, wearing proper gear can reduce the chance of injury when you ride.

Following are suggestions to help you choose proper gear.

⚠ WARNING

Not wearing a helmet increases the chance of serious injury or death in a crash.

Be sure you always wear a helmet, eye protection and other protective apparel when you ride.

Helmets and Eye Protection

Your helmet is your most important piece of riding gear because it offers the best protection against head injuries. A helmet should fit your head comfortably and have a chin strap that can be tightened securely.

An open-face helmet offers some protection, but a full-face helmet offers more. Always wear a face shield or goggles to protect your eyes and help your vision.

Additional Riding Gear

In addition to a helmet and eye protection, we also recommend:

- Sturdy off-road motorcycle boots to help protect your feet, ankles, and lower legs.
- Off-road motorcycle gloves to help protect your hands.
- Riding pants with knee and hip pads, a riding jersey with padded elbows, and a chest/shoulder protector.

LOAD LIMITS AND GUIDELINES

Your Honda was designed as a rider-only motorcycle. It was not designed to carry a passenger or cargo. A passenger or cargo could interfere with your ability to move around to maintain your balance and control of the motorcycle.

In addition, exceeding the weight limits or carrying an unbalanced load can seriously affect your motorcycle's handling, braking, and stability. Adding accessories or making modifications that change this motorcycle's design and performance can also make it unsafe. Also, the weight of any accessories will reduce the maximum load the motorcycle can carry.

The following pages give more specific information on loading, accessories and modifications.

Loading

How much weight you put on your motorcycle, and how you load it, are important to your safety. If you decide to carry cargo, you should be aware of the following information.

⚠ WARNING

Overloading or carrying a passenger can cause a crash and you can be seriously hurt or killed.

Follow all load limits and other loading guidelines in this manual.

Load Limits

Following are the load limits for your motorcycle:

Maximum weight capacity:

100 kg (220 lbs)

Includes the weight of the rider and any accessories

Loading Guidelines

As discussed on page 7, we recommend that you do not carry any cargo on this motorcycle. However, if you decide to carry cargo, ride at reduced speeds and follow these common-sense guidelines:

- Keep cargo small and light. Make sure it cannot easily be caught on brush or other objects, and that it does not interfere with your ability to shift position to maintain balance and stability.
- Place weight as close to the center of the motorcycle as possible.
- Do not attach large or heavy items (such as a sleeping bag or tent) to the handlebar, fork, or front fender.
- Make sure that all cargo is tied down securely.
- Never exceed the maximum weight limit.
- Check that both tyres are properly inflated (page 27).

Accessories and Modifications

Modifying your motorcycle or using non-Honda accessories can make your motorcycle unsafe. Before you consider making any modifications or adding an accessory, be sure to read the following information.

WARNING

Improper accessories or modifications can cause a crash in which you can be seriously hurt or killed.

Follow all instructions in this owner's manual regarding accessories and modifications.

Accessories

We strongly recommend that you use only genuine Honda accessories that have been specifically designed and tested for your motorcycle. Because Honda cannot test all other accessories, you must be personally responsible for proper selection, installation and use of non-Honda accessories. Check with your dealer for assistance and always follow these guidelines:

- Make sure the accessory does not reduce ground clearance and lean angle, limit suspension travel or steering travel, alter your riding position or interfere with operating any controls.

Modifications

We strongly advise you not to remove any original equipment or modify your motorcycle in any way that would change its design or operation. Such changes could seriously impair your motorcycle's handling, stability and braking, making it unsafe to ride.

Removing or modifying your exhaust system (such as the spark arresters or mufflers) or other equipment can also make your motorcycle illegal.

PARTS LOCATION

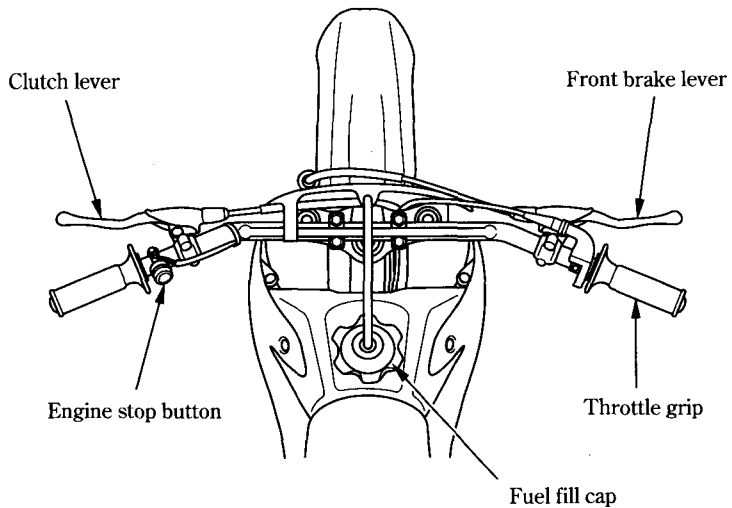

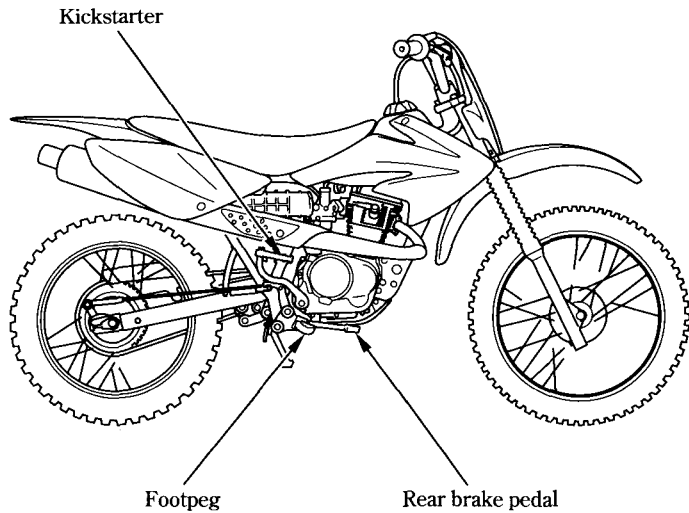

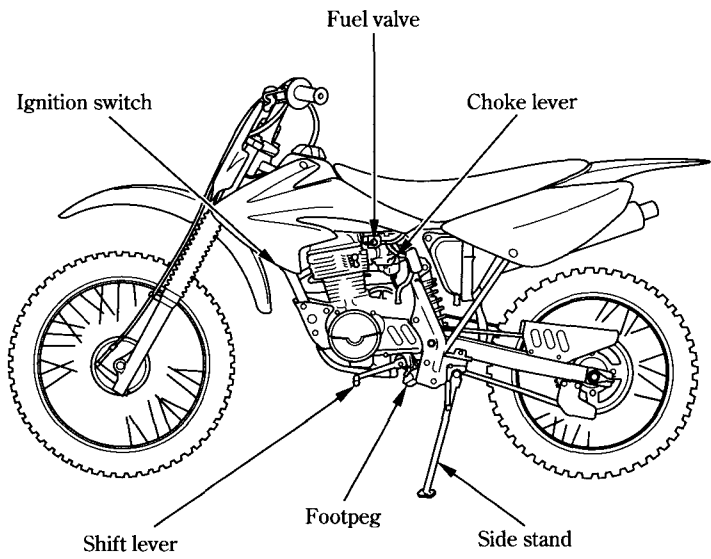

MAJOR COMPONENTS

(Information you need to operate this motorcycle)

BRAKES

Front Brake

Brakes are items of personal safety and should always be maintained in proper adjustment.

The distance the front brake lever or rear brake pedal moves before the brake starts to engage is called freeplay.

Measured at the tip of the front brake lever (1), freeplay should be maintained at:

20–30 mm (0.8–1.2 in)

Adjust the freeplay of the brake lever with the front wheel pointed straight ahead.

Adjustment:

1. Pull back the rubber dust cover (2). Loosen the lock nut (3) and turn the cable adjuster (4). Tighten the lock nut and check the adjustment.

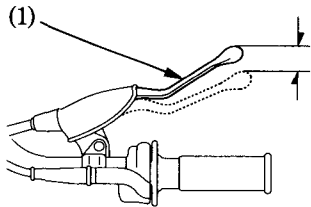

(1) Front brake lever

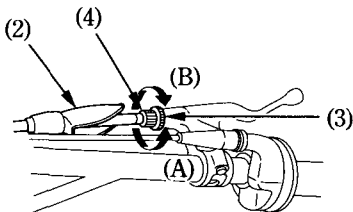

(2) Rubber dust cover (A) Decrease freeplay
(3) Lock nut (B) Increase freeplay
(4) Cable adjuster

- If the adjuster is threaded out near its limit or the correct freeplay cannot be obtained using the cable adjuster, loosen the lock nut and turn in the cable adjuster completely. Tighten the lock nut and install the rubber dust cover.
- Loosen the front brake cable guide bolt (5).

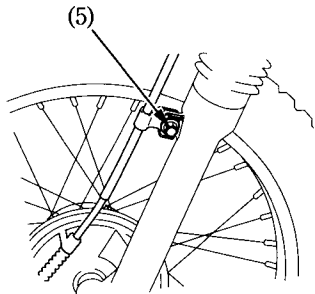

(5) Cable guide bolt

- Loosen the lock nut (6) at the lower end of the cable. Turn the adjusting nut (7) to obtain the specified freeplay. Tighten the lock nut and check the adjustment.

If proper adjustment cannot be obtained by this method, see your Honda dealer.

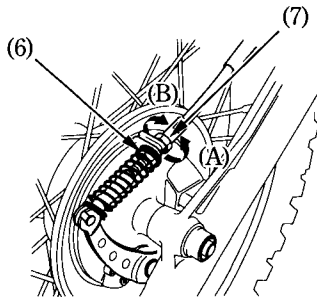

(6) Lock nut
(7) Adjusting nut

(A) Decrease freeplay
(B) Increase freeplay