

**2008
Honda TRX680FA/FGA
FOURTRAX RINCON/with GPScape
OWNER'S MANUAL**

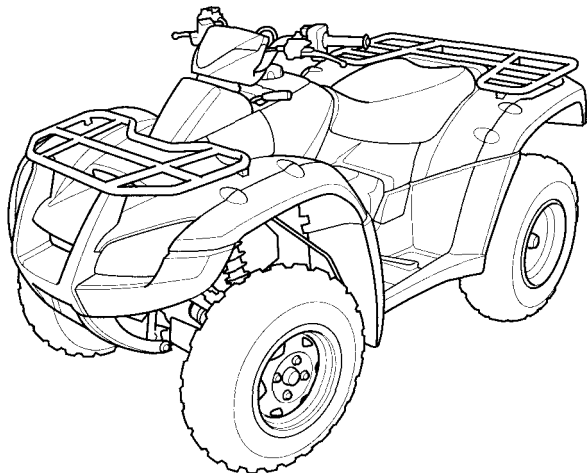

FOR OFF-ROAD USE ONLY

This vehicle is designed and manufactured for off-road use only.
USA only:

It conforms to US EPA Noise Emission regulations, but does not conform to Federal Motor Vehicle Safety Standards or US EPA On Highway Exhaust Emission regulations, and operation on public streets, roads, or highways is illegal. The vehicle is equipped with a USDA qualified spark arrester. Obey local laws and regulations.

It conforms to US EPA, California, and Environment Canada exhaust emission regulations for ATVs.

Introduction

Congratulations on choosing your Honda ATV.

When you own a Honda, you're part of a worldwide family of satisfied customers — people who appreciate Honda's reputation for building quality into every product.

Your Honda was designed as a recreational ATV for off-road use by one rider only.

Before riding, take time to get acquainted with your ATV and how it works. To protect your investment, we urge you to take responsibility for keeping your ATV well maintained. Scheduled service is a must, of course. But it's just as important to observe the break-in guidelines, and perform all pre-ride and other periodic checks detailed in this manual.

We also recommend that you read this owner's manual before you ride. It's full of facts, instructions, safety information, and helpful tips. To make it easy to use, the manual contains a detailed list of topics at the beginning of each section, and both an in-depth table of contents and an index at the back of the book.

As you read this manual, you will find information that is preceded by a **NOTICE** symbol. This information is intended to help you avoid damage to your Honda, other property, or the environment.

Read the Warranties Booklet (page 251) thoroughly so you understand the coverages that protect your new Honda and are aware of your rights and responsibilities.

Whenever you ride, tread lightly. By staying on established trails and riding only in approved areas, you help protect the environment and keep off-road riding areas open for the future.

Introduction

If you have any questions, or if you ever need special service or repairs, remember that your Honda dealer knows your ATV best and is dedicated to your complete satisfaction.

Please report any change of address or ownership to your Honda dealer so we will be able to contact you concerning important production information.

You may also want to visit our website at www.honda.com.

Happy riding!

California Proposition 65 Warning

WARNING: This product contains or emits chemicals known to the State of California to cause cancer and birth defects or other reproductive harm.

A Few Words About Safety

Your safety, and the safety of others, is very important. And operating this ATV safely is an important responsibility.

To help you make informed decisions about safety, we have provided operating procedures and other information on labels and in this manual. This information alerts you to potential hazards that could hurt you or others.

Of course, it is not practical or possible to warn you about all hazards associated with operating or maintaining an ATV. You must use your own good judgment.

You will find important safety information in a variety of forms, including:

Safety Labels — on the ATV.

Safety Messages — preceded by a safety alert symbol  and one of three signal words: **DANGER**, **WARNING**, or **CAUTION**.

A Few Words About Safety

These signal words mean:

⚠ DANGER

You **WILL** be **KILLED** or **SERIOUSLY HURT** if you don't follow instructions.

⚠ WARNING

You **CAN** be **KILLED** or **SERIOUSLY HURT** if you don't follow instructions.

⚠ CAUTION

You **CAN** be **HURT** if you don't follow instructions.

Safety Headings — such as Important Safety Reminders or Important Safety Precautions.

Safety Section — such as ATV Safety.

Instructions — how to use this ATV correctly and safely.

This entire manual is filled with important safety information — please read it carefully.

Contents

These pages give an overview of the contents of your owner's manual. The first page of each section lists the topics covered in that section.

| | |
|---|-----------|
| ATV Safety | 1 |
| Important safety information you should know, plus a look at the safety-related labels on your ATV. | |
| Instruments & Controls..... | 9 |
| The location and function of indicators and controls on your ATV and operating instructions for various controls and features. | |
| GPScape System (TRX680FGA only) | 45 |
| Instructions for use of your ATV Navigation System. | |
| Before Riding..... | 73 |
| The importance of wearing a helmet and other protective gear, how to make sure you and your ATV are ready to ride, and important information about loading. | |
| Basic Operation & Riding | 89 |
| How to start and stop the engine, shift gears, and brake. Also, riding precautions. | |

Contents

| | |
|---|-----|
| Servicing Your Honda | 125 |
| Why your ATV needs regular maintenance, what you need to know before servicing your Honda, an owner maintenance schedule, and instructions for specific maintenance and adjustment items. | |
| Tips | 201 |
| How to store and transport your ATV and how to be an environmentally-responsible rider. | |
| Taking Care of the Unexpected | 211 |
| What to do if you have a flat tire, your engine won't start, etc. | |
| Technical Information | 233 |
| ID numbers, technical specifications, and other technical facts. | |
| Consumer Information | 247 |
| Information on warranties, emission controls, how to get Honda service manuals. | |
| Table of Contents | 256 |
| Sequential listing of topics in this owner's manual. | |
| Index | 264 |
| Quick Reference | |
| Handy facts about fuel, engine oil, tire sizes, and air pressures. | |

ATV Safety

This section presents some of the most important information and recommendations to help you ride your ATV safely. Please take a few moments to read these pages. This section also includes information about the location of safety labels on your ATV.

| | |
|------------------------------------|---|
| Important Safety Information | 2 |
| Safety Labels..... | 5 |

Important Safety Information

Your ATV can provide many years of service and pleasure — if you take responsibility for your own safety and understand the challenges you can meet while riding.

There is much that you can do to protect yourself when you ride. You'll find many helpful recommendations throughout this manual. The following are a few that we consider most important.

Follow the Age Recommendation

The minimum recommended age for this ATV model is 16. Children under age 16 should never operate this vehicle.

Always Wear a Helmet

It's a proven fact: helmets significantly reduce the number and severity of head injuries. So always wear an approved motorcycle helmet. We also recommend that you wear eye protection, sturdy boots, gloves, and other protective gear (page 74).

Never Carry a Passenger

Your ATV is designed for one person only. There are no handholds, footrests, or seat for a second person — so never carry a passenger. A passenger could interfere with your ability to move around to maintain your balance and control of the ATV.

Important Safety Information

Ride Off-Road Only

Your ATV is designed and manufactured for off-road use only. The tires are not made for pavement, and the ATV does not have turn signals and other features required for use on public roads. If you need to cross a paved or public road, get off and walk your ATV across.

Take Time to Learn & Practice

Even if you have ridden other ATVs, take time to become familiar with how this ATV works and handles. Practice in a safe area until you build your skills and get accustomed to the ATV's size and weight.

Because many accidents involve inexperienced or untrained riders, we urge all riders to take a training course approved by the ATV Safety Institute (ASI). See page 76.

Contact an authorized ATV dealer or call 1-800-887-2887 (USA only) to find out about the training courses nearest you.

Be Alert for Off-Road Hazards

The terrain can present a variety of challenges when you ride off-road. Continually "read" the terrain for unexpected turns, drop-offs, rocks, ruts, and other hazards. Always keep your speed low enough to allow time to see and react to hazards.

Important Safety Information

Ride within Your Limits

Pushing limits is another major cause of ATV accidents. Never ride beyond your personal abilities or faster than conditions warrant. Remember that alcohol, drugs, fatigue, and inattention can significantly reduce your ability to make good judgments and ride safely.

Don't Drink and Ride

Alcohol and riding don't mix. Even one drink can reduce your ability to respond to changing conditions, and your reaction time gets worse with every additional drink. So don't drink and ride, and don't let your friends drink and ride either.

Keep Your Honda in Safe Condition

It's important to keep your ATV properly maintained and in safe riding condition. Having a breakdown can be difficult, especially if you are stranded off-road far from your base. To help avoid problems, inspect your ATV before every ride and perform all recommended maintenance.

Safety Labels

Your ATV comes with a hang tag and several labels containing important safety information. Anyone who rides the vehicle should read and understand this information before riding.

The labels should be considered permanent parts of the vehicle. If a label comes off or becomes hard to read, contact your Honda dealer for replacements.

Safety Labels

USA only

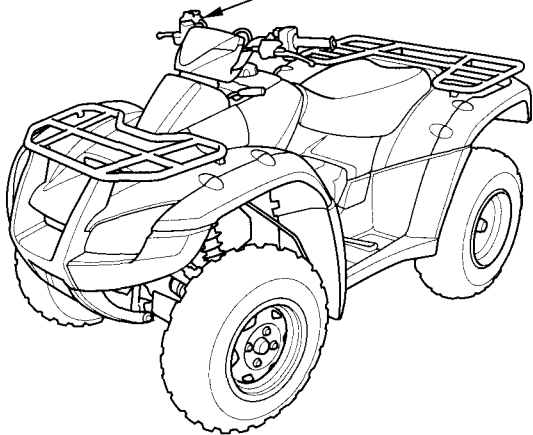
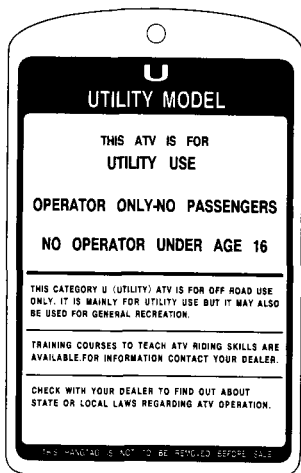
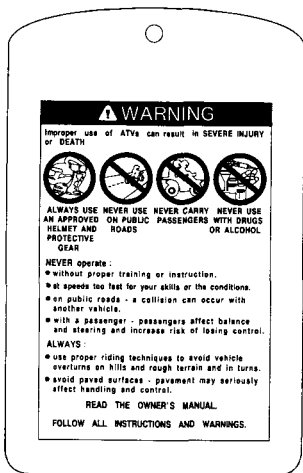

Safety Labels

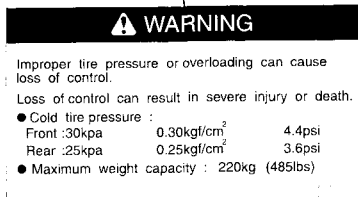
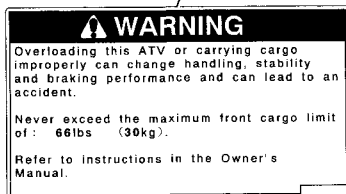
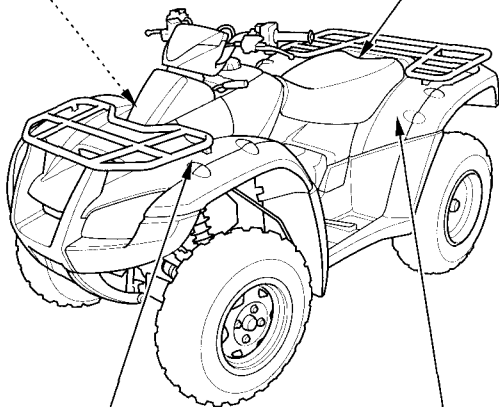

Safety Labels

WARNING



Operating this ATV if you are under the age of 16 increases your chance of severe injury or death.

NEVER operate this ATV if you are under age 16.

BRAKING INFORMATION

With four-wheel drive operating any brake control causes braking at both the front and rear wheels. For detailed braking information, refer to the Owner's Manual.

WARNING

Overloading this ATV or carrying cargo improperly can change handling, stability and braking performance and can lead to an accident.

Never exceed the maximum rear cargo limit (combined weight on the rear rack and in the storage area) of: 133lbs (60kg).

Refer to instructions in the Owner's Manual.

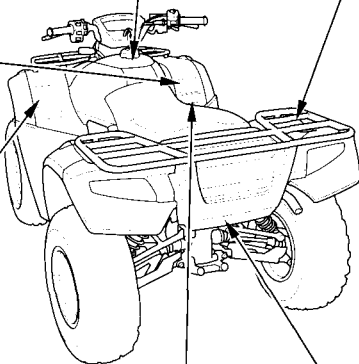

WARNING

Improper use of ATVs can result in SEVERE INJURY or DEATH



ALWAYS USE AN APPROVED HELMET AND PROTECTIVE GEAR. NEVER USE ON PUBLIC ROADS. NEVER CARRY PASSENGERS WITH DRUGS OR ALCOHOL. NEVER USE ON PUBLIC ROADS OR ALCOHOL.

NEVER operate:

- without proper training or instruction.
- at speeds too fast for your skills or the conditions.
- on public roads - a collision can occur with another vehicle.
- with a passenger - passengers affect balance and steering and increase risk of losing control.

ALWAYS:

- use proper riding techniques to avoid vehicle overturns on hills and rough terrain and in turns.
- avoid paved surfaces - pavement may seriously affect handling and control.

READ THE OWNER'S MANUAL.

FOLLOW ALL INSTRUCTIONS AND WARNINGS.

WARNING

Towing an Improperly loaded trailer can cause loss of control.

- Read owner's manual.
- Tow weight limit :3776N {385kgf} 850lbs
- Tongue weight : 137N { 14kgf} 30lbs

(For Canada)

THIS VEHICLE IS AN ALL-TERRAIN VEHICLE AND IS NOT INTENDED FOR USE ON PUBLIC HIGHWAYS.

CE VÉHICULE EST UN VÉHICULE TOUT TERRAIN ET DONT L'USAGE N'EST PAS DESTINÉ AUX VOIES PUBLIQUES.

Instruments & Controls

This section shows the location of all indicators and controls you would normally use before or while riding your ATV.

The items listed on this page are described in this section. Instructions for other components are presented in other sections of this manual where they will be most useful.

| | |
|-------------------------------------|----|
| Operation Component Locations | 11 |
| Indicators & Displays | 14 |
| Multi-function Display | 19 |
| Drive Mode Indicator | 20 |
| Gear Position Indicator | 21 |
| Oil Change Indicator | 22 |
| Odometer | 23 |
| Tripmeter | 23 |
| Hourmeter | 25 |
| Digital Clock | 26 |
| Fuel Gauge | 29 |

(cont'd)

Instruments & Controls

| | |
|-------------------------------|----|
| Controls & Features | 30 |
| Ignition Switch | 30 |
| Shift Lever | 31 |
| Drive Mode Select Switch..... | 32 |
| 2WD/4WD Select Switch | 33 |
| Start Button | 34 |
| Engine Stop Switch..... | 34 |
| Headlight Switch..... | 35 |
| Headlight Dimmer Switch..... | 35 |
| Recoil Starter..... | 36 |
| Throttle Lever | 37 |
| Gearshift Switch..... | 38 |
| Front Brake Lever | 39 |
| Rear Brake Lever | 39 |
| Rear Brake Pedal..... | 39 |
| Parking Brake..... | 40 |
| Flag Pole Bracket | 41 |
| Accessory Socket | 42 |

Operation Component Locations

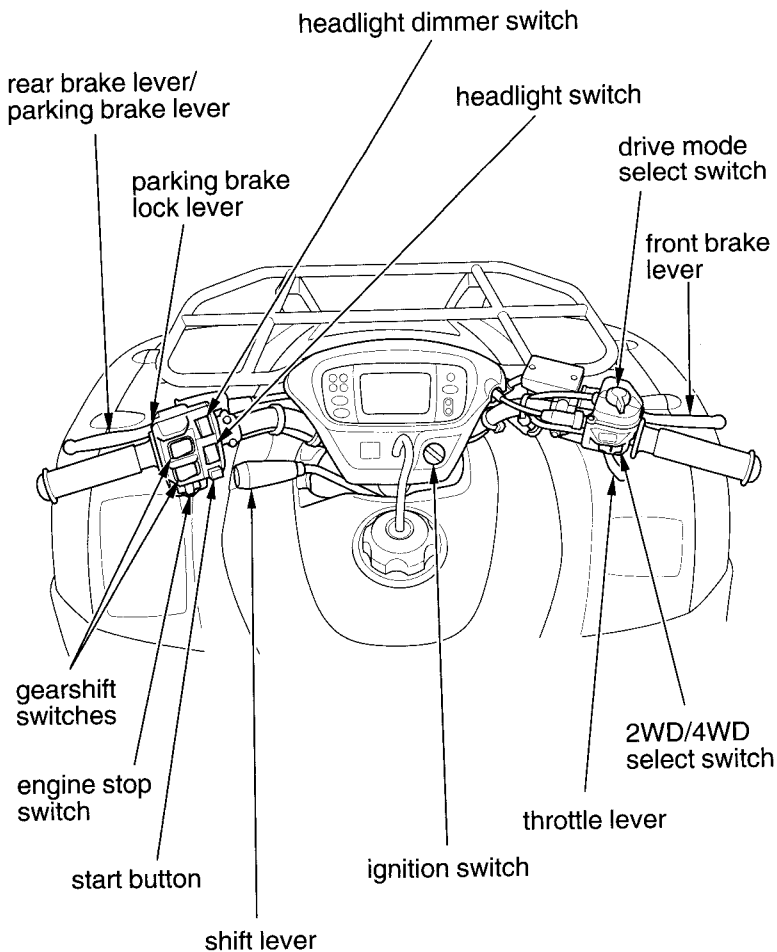

Operation Component Locations

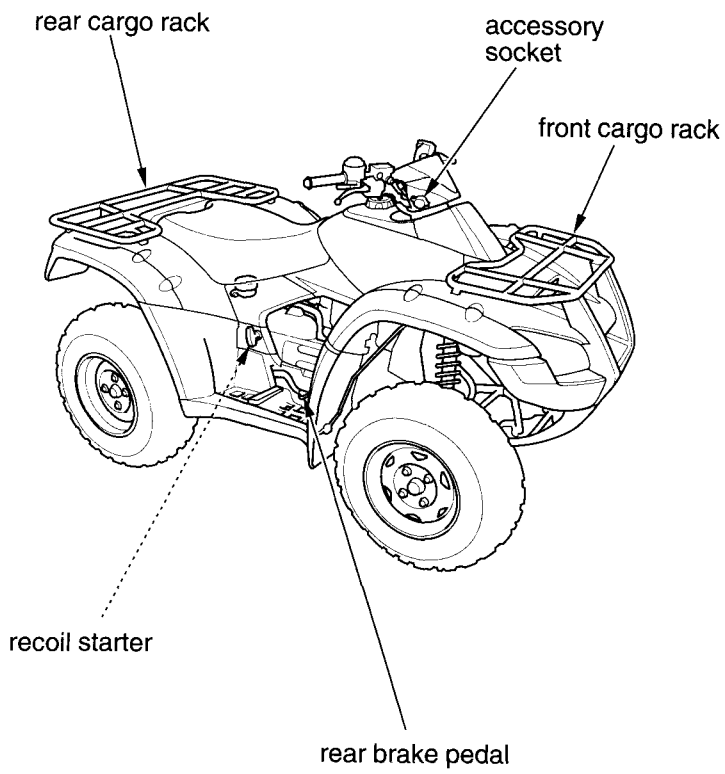

Operation Component Locations

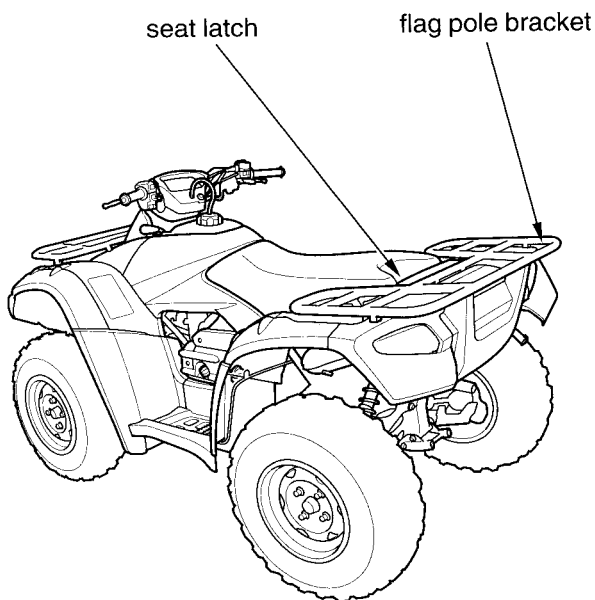

Indicators & Displays

The indicators and displays on your ATV keep you informed, alert you to possible problems, and make your riding safer and more enjoyable. Refer to the indicators frequently. Their functions are described on the following pages.

TRX680FA

TRX680FGA

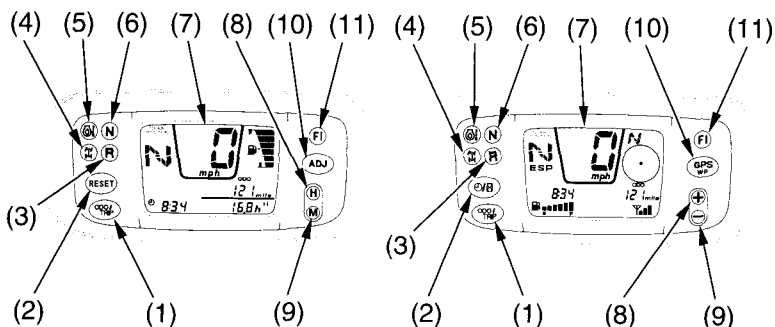

- (1) odometer/tripmeter select button
- (2) RESET button
- hourmeter/digital clock select button (TRX680FGA)
- (3) reverse indicator
- (4) 4WD indicator
- (5) high oil/coolant temperature indicator
- (6) neutral indicator
- (7) multi-function display
- (8) hour select button
- plus button (TRX680FGA)
- (9) minute select button
- minus button (TRX680FGA)
- (10) ADJ button
- GPS/WP button (TRX680FGA)
- (11) PGM-FI indicator

Indicators & Displays

Lamp Check

The high oil/coolant temperature indicator, 4WD indicator, neutral indicator, reverse indicator and PGM-FI indicator comes on for a few seconds and then go off when you turn the ignition switch ON (I). This indicator is identified in the table on page 16 with the words: *Lamp Check*.

When applicable, the reverse or neutral indicators come on when you turn the ignition switch ON (I) and remain on until you shift out of reverse or neutral.

If one of these indicators does not come on when it should, have your Honda dealer check for problems.

Display Check

When the ignition switch is turned ON (I), the multi-function display (1) will temporarily show all the modes and digital segments so you can make sure the liquid crystal display is functioning properly.

The displays are identified in the table on page 16 with the words: *Display Check*.

If any part of these displays does not come on when it should, have your Honda dealer check for problems.

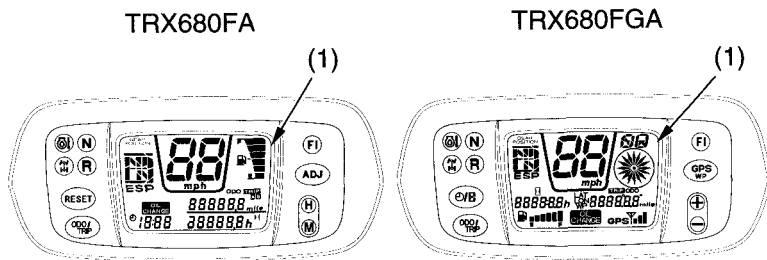

(1) multi-function display

Indicators & Displays

| | | |
|---|--|---|
| 1 | Odometer/tripmeter select button | Selects display of the odometer or tripmeter A or tripmeter B (page 24). This button also used to reset the oil change indicator (page 22). |
| | Odometer/tripmeter select button (TRX680FGA) | Selects display of the odometer or tripmeter. Resets the tripmeter to zero (0) (page 23). This button also used to reset the oil change indicator (page 22). |
| 2 | RESET button | Resets the tripmeter to zero (0) (page 23). This button also used to reset the oil change indicator (page 22). |
| | Digital clock/ hourmeter select button (TRX680FGA) | Selects display of the hourmeter or digital clock (pages 25 , 27). |
| 3 | Reverse indicator | Lights when the transmission is in reverse. <i>Lamp check.</i> |
| 4 | 4WD indicator | Lights when the drive mode is in the 4WD mode. The 4WD indicator blinks if there is a possible problem with the 2WD/4WD select system. See your Honda dealer as soon as possible. <i>Lamp check.</i> |
| 5 | High oil/coolant temperature indicator | Lights when engine oil and/or coolant temperature is high enough to adversely affect the service life of the engine. If the high oil/coolant temperature indicator comes on while you are riding, immediately bring the vehicle to a stop, turn the engine off and let it cool. See page222. <i>Lamp Check.</i> |

Indicators & Displays

| | | |
|---------------|--|---|
| 6 | Neutral indicator | Lights when the transmission is in neutral. <i>Lamp Check.</i> |
| 7 | Multi-function display | The display includes the following functions. <i>Display Check.</i> |
| | Drive mode indicator | Shows the driving mode (page 20). |
| | Gear position indicator | Shows the gear position (page 21). |
| | Speedometer | Shows riding speed. |
| | Fuel gauge | Shows approximate fuel supply available (page 29). |
| | Oil change indicator | Lights when specified maintenance interval for engine oil change is reached (page 22). |
| | Odometer | Shows accumulated mileage (page 23). |
| | Tripmeter | Shows mileage per trip (page 23). |
| | Hourmeter | Shows hours and tenths of hours of engine operation (page 25). |
| Digital clock | Shows the time (hours and minutes) (page 26). | |

Indicators & Displays

| | | |
|----|-------------------------------|---|
| 8 | Hour select button | Advances the hour displayed by the digital clock (page 26). |
| | Plus button (TRX680 FGA) | Advances the latitude and longitude when in the GPS mode. |
| 9 | Minute select button | Advances the minutes displayed by the digital clock (page 26). |
| | Minus button (TRX680 FGA) | Advances the latitude and longitude when in the GPS mode. |
| 10 | ADJ button | Used to set the digital clock (page 26). |
| | GPS/WP button (TRX680 FGA) | This button is used to select the GPS navigation mode and input a waypoint or to erase waypoint data. |
| 11 | PGM-FI indicator | Lights when there is any abnormality in the PGM-FI (Programmed Fuel Injection) system. Should also light for a few seconds and then go off when the ignition switch is turned ON and use the start button. If the indicator comes on at any other time, reduce speed and take your vehicle to a Honda dealer as soon as possible. <i>Lamp Check.</i> |

Indicators & Displays

Multi-function Display

The multi-function display (1) includes the following functions:

| | | |
|-------------------------|-------------|---------------|
| Drive mode indicator | Speedometer | Digital clock |
| Gear position indicator | Odometer | Hourmeter |
| Oil change indicator | Tripmeter | Fuel gauge |

The digital clock will reset if the battery is disconnected.

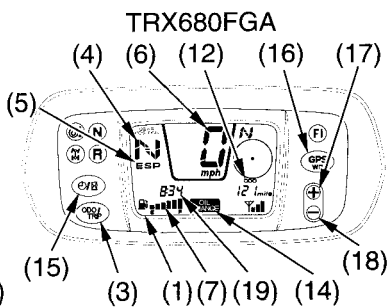
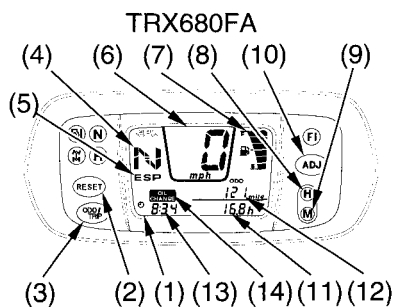

- | | |
|--------------------------------------|--|
| (1) multi-function display | (12) odometer/tripmeter |
| (2) RESET button (TRX680FA) | (13) digital clock (TRX680FA) |
| (3) odometer/tripmeter select button | (14) oil change indicator |
| (4) gear position indicator | (15) digital clock/hourmeter select button (TRX680FGA) |
| (5) drive mode indicator | (16) GPS/WP button (TRX680FGA) |
| (6) speedometer | (17) plus button (TRX680FGA) |
| (7) fuel gauge | (18) minus button (TRX680FGA) |
| (8) hour select button (TRX680FA) | (19) digital clock/hourmeter (TRX680FGA) |
| (9) minute select button (TRX680FA) | |
| (10) ADJ button (TRX680FA) | |
| (11) hourmeter (TRX680FA) | |

Indicators & Displays

Drive Mode Indicator

The drive mode indicator (1) shows the selected drive mode when the ignition switch is in the ON (I) position.

The drive mode indicator (1) displays ESP when the manual shift (ESP) mode is selected. The ESP display vanishes when the automatic shift (AUTO) mode is selected.

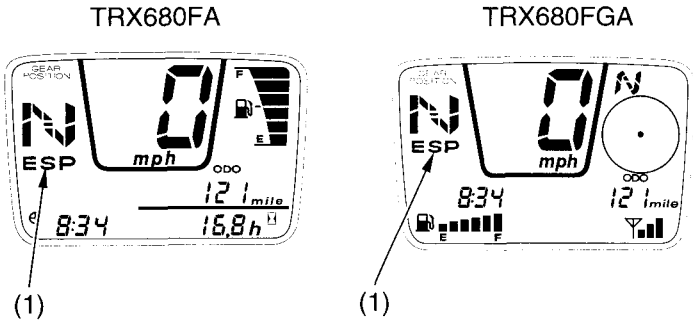

(1) drive mode indicator

Indicators & Displays

Gear Position Indicator

The gear position indicator (1) shows the gear position when the ignition switch is in the ON (I) position.

The indicator displays: N for neutral, R for reverse, D for drive, and 1 – 3 for the three forward speed positions in the ESP mode.

“- -” will be displayed on the gear position indicator when the transmission is not shifted into gear properly. Before riding, check that the gear position is properly displayed on the gear position indicator.

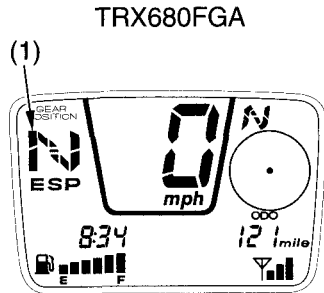
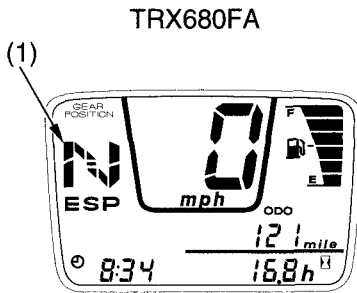

(1) gear position indicator

Indicators & Displays

Oil Change Indicator

The oil change indicator (1) appears in the display when the mileage or operating hours on your ATV approaches the oil change interval specified on the maintenance schedule.

Reset the indicator after each oil change.

(For TRX680FA)

To reset the indicator, press and hold both the odometer/tripmeter select button (2) and RESET button (3) for more than 2 seconds. The indicator will disappear.

(For TRX680FGA)

To reset the indicator, press and hold both the odometer/tripmeter select button (2) and digital clock/hourmeter select button (4) for more than 2 seconds. The indicator will disappear.

If the oil is changed before the oil change indicator appears, be sure to reset the oil change indicator after changing the oil. The indicator will appear for 2 seconds, then disappear. This means the indicator is reset.

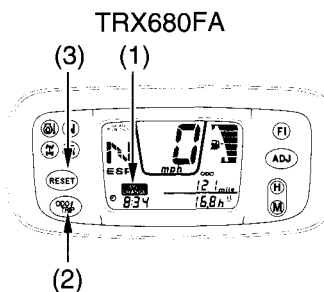

- (1) oil change indicator
- (2) odometer/tripmeter select button

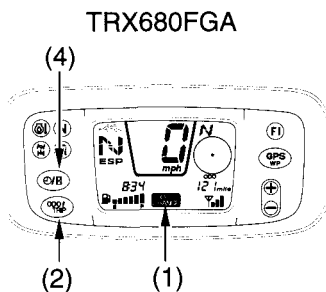

- (3) RESET button
- (4) digital clock/hourmeter select button

Indicators & Displays

Odometer

When selected, the odometer (1) registers total distance traveled in miles while the ignition is ON (1). To change the display from tripmeter to odometer, press and release the odometer/tripmeter select button (2).

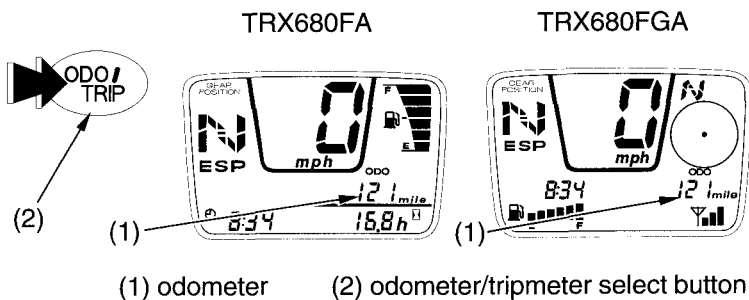

Tripmeter

(For TRX680FGA)

When selected, the tripmeter (3) shows mileage per trip while the ignition is ON (1). To change the display from odometer to tripmeter, press and release the odometer/tripmeter select button (2). To reset the tripmeter to zero, press the odometer/tripmeter select button and hold it in for at least 2 seconds.

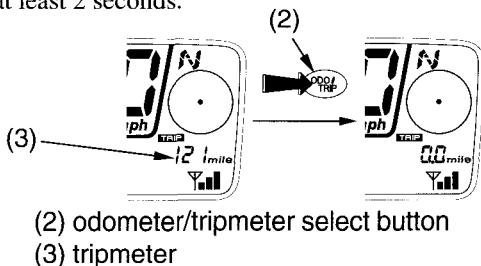

(cont'd)

Indicators & Displays

(For TRX680FA)

The tripmeter has two sub modes, A (4) and B (5).

To change the display from tripmeter A or tripmeter B to odometer, press and release the odometer/tripmeter select button (2).

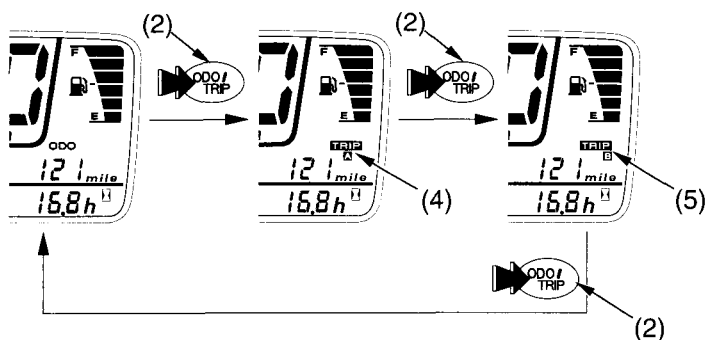

(4) tripmeter A

(5) tripmeter B

To reset the tripmeter to zero, press and hold the RESET button (6) for more than 2 seconds with the display in the tripmeter A or tripmeter B mode.

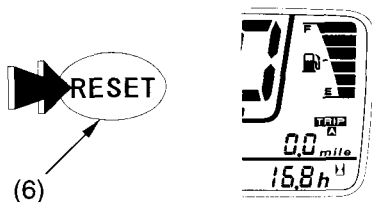

(6) RESET button

Indicators & Displays

Hourmeter

The hourmeter (1) shows accumulated hours while the ignition is ON (1). The hourmeter provides accurate service period information for initial and regular maintenance.

TRX680FA

TRX680FGA

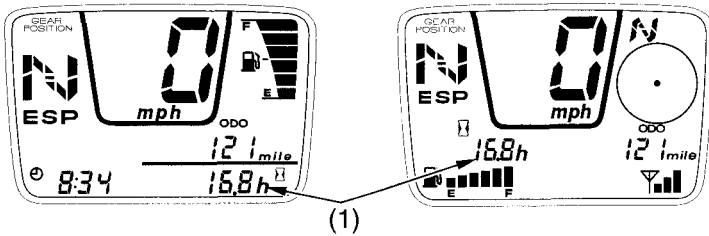

(1) hourmeter

(For TRX680FGA)

To change the display from the digital clock to the hourmeter, press and release the digital clock/hourmeter select button (2). The hourmeter mark (3) will appear.

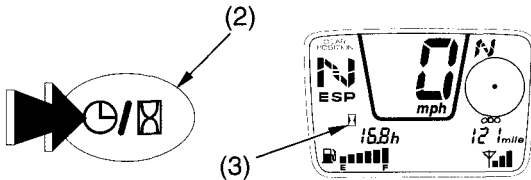

(2) hourmeter/digital clock
select button

(3) hourmeter mark

Indicators & Displays

Digital Clock

Shows hour and minute while the ignition is ON (1).

To adjust the time, proceed as follows.

(For TRX680FA)

1. Turn the ignition switch ON (1).
2. To select the adjust mode, push the ADJ button (1) once.
3. To advance the hour display one unit at a time, press and release the hour select button (2).

To advance the hour display automatically, press and hold the hour select button. After 2 seconds, the hour display will begin advancing. Release the button when the display reaches the desired hour.

4. To advance the minute display one unit at a time, press and release the minute select button (3).

To advance the minute display automatically, press and hold the minute select button. After 2 seconds, the minute display will begin advancing. Release the button when the display reaches the desired minute.

To zero the minute display, press and hold both the hour and minute select buttons simultaneously for 2 seconds.

5. Press the ADJ button when the display reaches the desired minute. The display will stop flashing.

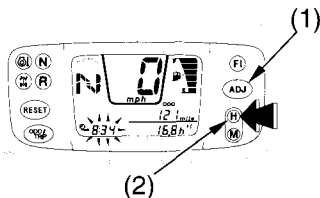

- (1) ADJ button
(2) hour select button

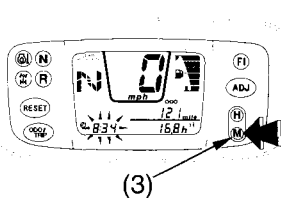

- (3) minute select button

Indicators & Displays

(For TRX680FGA)

1. Turn the ignition switch ON (1).
 - To change the display from hourmeter to digital clock, press and release the digital clock/hourmeter select button (1).
2. Press and hold the digital clock/hourmeter select button for more than 2 seconds. The clock will be set in the adjust mode with the hour display flashing.
3. To advance the hour display one unit at a time, press and release the plus button (2) or minus button (3).
To advance the hour display automatically, press and hold the plus button or minus button. After 2 seconds, the hour display will begin advancing. Release the button when the display reaches the desired hour.

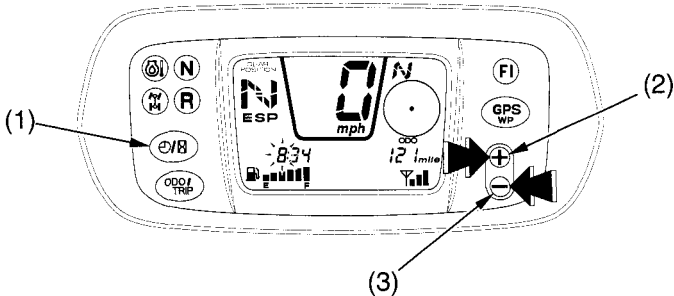

(1) hourmeter/digital clock
select button

(2) plus button

(3) minus button

(cont'd)

Indicators & Displays

4. Press the digital clock/hourmeter select button when the display reaches the desired hour appears. The minutes display will be flashing.

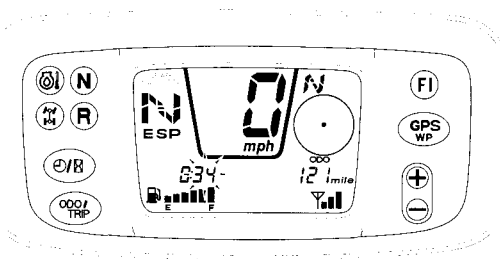

5. To advance the minute display one unit at a time, press and release the plus button or minus button.
To advance the minute display automatically, press and hold the plus button or minus button. After 2 seconds, the minute display will begin advancing. Release the button when the display reaches the desired minute.
6. Press the digital clock/hourmeter select button when the display reaches the desired minutes appears. The display will stop flashing.
 - Your ATV's digital clock has an automatic adjustment function whenever the GPS mode is selected and the system's satellite status is 3D Navigation (page 72).

Indicators & Displays

Fuel Gauge

The fuel gauge liquid crystal display (1) shows the approximate fuel supply available. The fuel tank capacity is:

4.44 US gal (16.8 ℓ)

When segment E (2) and low fuel indicator (3) flash, you should refill the tank as soon as possible. The amount of fuel remaining when the flashing starts is approximately:

1.40 US gal (5.3 ℓ)

TRX680FA

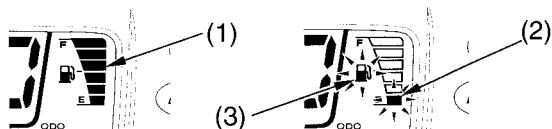

TRX680FGA

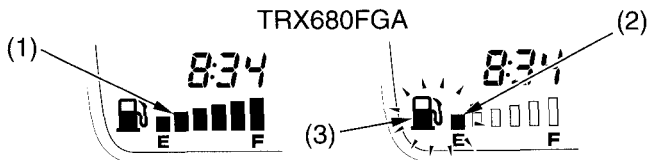

(1) fuel gauge
(2) segment E

(3) low fuel indicator

All segments will flash, when the fuel gauge function is fails. See your Honda dealer.

TRX680FA

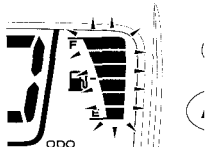

TRX680FGA

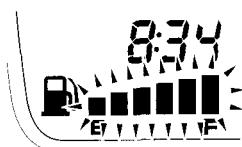

Controls & Features

Ignition Switch

The ignition switch (1) is used for starting and stopping the engine (page 96). Insert the key and turn it to the right for the ON (|) position.

| Key Position | Function |
|--------------|----------------------------------|
| ON () | Electrical circuits on. |
| OFF (○) | No electrical circuits function. |

CENTER OF HANDLEBAR

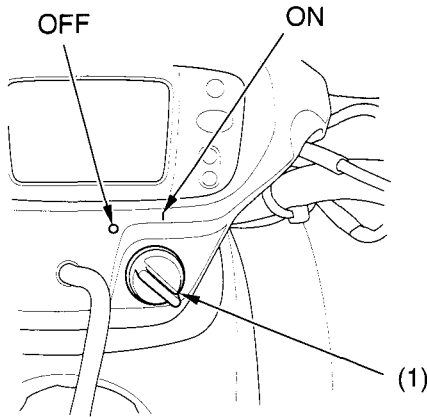

(1) ignition switch

| ON
○ OFF

Controls & Features

Shift Lever

The shift lever (1) has three positions: drive (D), neutral (N), and reverse (R).

See *Shifting Gears* (page102) and *Riding in Reverse* (page108).

LEFT SIDE OF HANDLE COVER

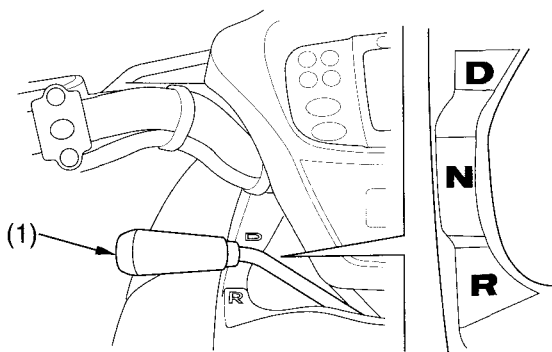

(1) shift lever

Controls & Features

Drive Mode Select Switch

The drive mode select switch (1) has two positions, AUTO and ESP. See *Shifting Gears* page 102.

RIGHT HANDLEBAR

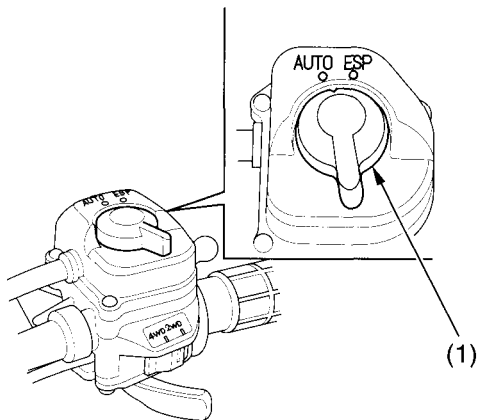

(1) drive mode select switch

Controls & Features

2WD/4WD Select Switch

Your ATV is equipped with a 2WD/4WD select switch (1), which permits a choice between the “2WD” and “4WD” drive modes. Select a drive mode that’s suitable for your riding.

The 2WD/4WD select switch is located above the throttle lever. To select the drive mode, slide the 2WD/4WD select switch to the desired position.

To check your present drive mode, look at the 4WD indicator (2).

2WD mode: the 4WD indicator goes off.

4WD mode: the 4WD indicator goes on.

4WD can only be engaged while the engine is running.

It remains engaged until the 2WD mode is selected or the engine is stopped.

Upon starting, your ATV will be in the 2WD mode, regardless of the 2WD/4WD select switch position.

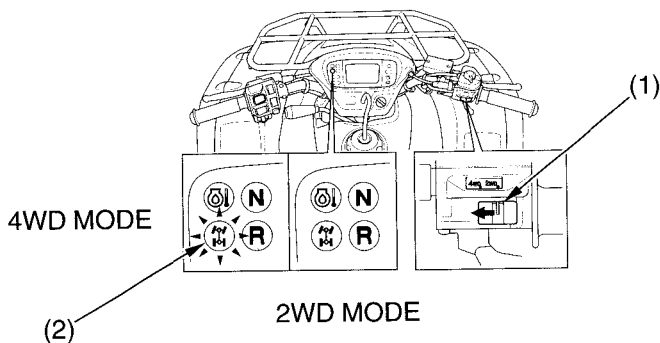

(1) 2WD/4WD select switch

(2) 4WD indicator

Controls & Features



Start Button

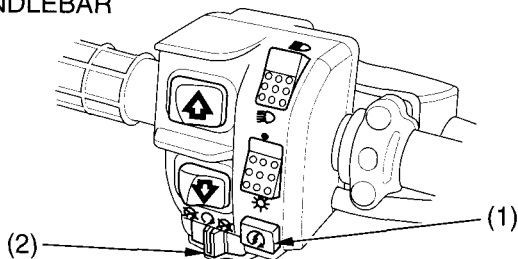

LEFT HANDLEBAR



- (1) start button
- (2) engine stop switch



-  START
-  RUN
-  OFF



The start button (1) is used for starting the engine. Pushing the button in starts the engine. See *Starting Procedure*, page 97.

When the start button is pushed, the starter motor will crank the engine. The starter motor will not operate if the engine stop switch is in the OFF () position when the start button is pushed.

Engine Stop Switch



The engine stop switch (2) is used to stop the engine in an emergency. To operate, slide the switch to the OFF () position. The switch must be in the RUN () position to start the engine, and it should normally remain in the RUN () position even when the engine is OFF.

If your ATV is stopped with the ignition switch ON () and the engine stop switch OFF (), the battery will discharge. Turn the ignition switch OFF () to prevent battery discharge.

Controls & Features

Headlight Switch



LEFT HANDLEBAR

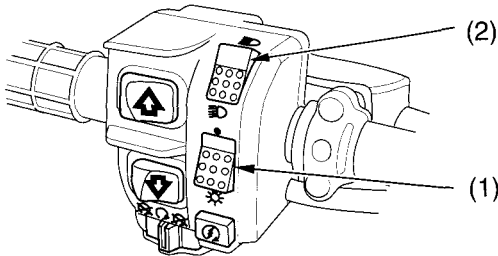

(1) headlight switch

(2) headlight dimmer switch

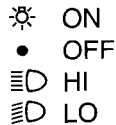

The headlight switch (1) is used to turn the headlight ON (☀) or OFF (•). To operate, turn the switch to ON (☀) or OFF (•).

Headlight Dimmer Switch



The headlight dimmer switch (2) is used to change between the high and low beams of the headlight. To operate, turn the switch to HI (≡D) for high beam, LO (≡D) for low beam.

Controls & Features

Recoil Starter

RIGHT SIDE

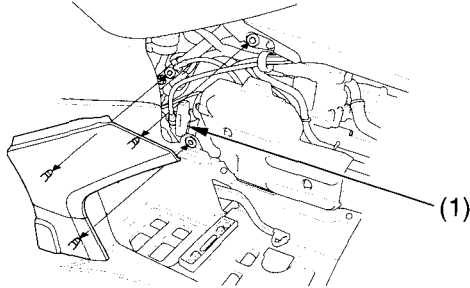

(1) recoil starter

The recoil starter (1) is used to start the engine when the battery is low. See *Using the Recoil Starter*, page 101.

Controls & Features

Throttle Lever

RIGHT HANDLEBAR

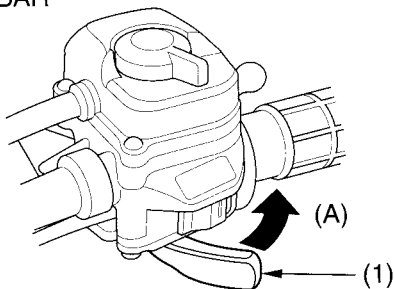

- (1) throttle lever
- (A) to open the throttle

The throttle controls engine rpm (speed). To increase engine rpm, press the throttle lever (1) with your thumb. To reduce engine rpm, release pressure on the throttle lever. The throttle will automatically return to the closed position (engine idle) when you remove your thumb.

Controls & Features

Gearshift Switch

Two gearshift switches are used in the ESP (manual shift) mode. These switches are used to select the next higher or lower gear in the transmission. To operate, press the upshift switch (1) to engage the next higher gear or press the downshift switch (2) to engage the next lower gear. See *Shifting Gears*, page 102.

LEFT HANDLEBAR

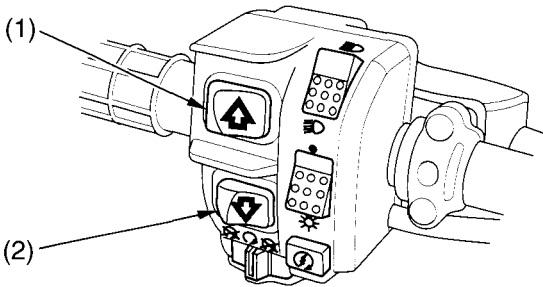

(1) upshift switch

(2) downshift switch

Controls & Features

Front Brake Lever

The front brake lever is used to slow or stop your ATV. To operate, pull the lever. For information on braking techniques, see page 110.

Rear Brake Lever

The rear brake lever/parking brake lever is used to slow or stop your ATV. To operate, pull the lever. For information on braking techniques, see page 110.

Rear Brake Pedal

The rear brake pedal is used to slow or stop your ATV. To operate, depress the pedal. For information on braking techniques, see page 110.

Controls & Features

Parking Brake

LEFT HANDLEBAR

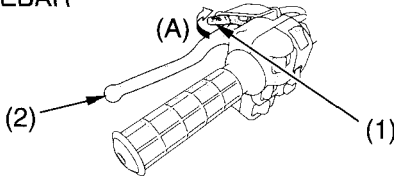

(1) lock lever

(2) rear brake lever/parking brake lever (A) to lock

The lock lever (1) on the rear brake lever/parking brake lever (2) allows it to be used as a parking brake. To operate, first squeeze the rear brake lever/parking brake lever using your left hand and then lock it with the lock lever using your right hand. See *Parking* page 124.

The brakelights are activated by applying the parking brake. When using the parking brake, be sure to turn the ignition switch OFF (O) to avoid discharging the battery.

Controls & Features

Flag Pole Bracket

RIGHT REAR

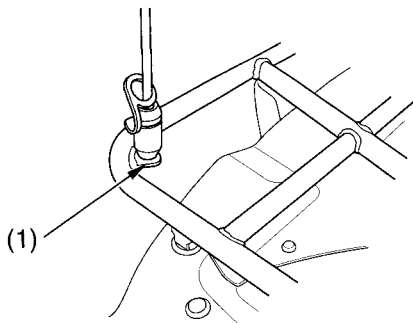

(1) flag pole bracket

Flag poles are optional equipment available from your Honda dealer. To mount a pole in the bracket (1), follow the instructions that come with the flag pole kit.

Flag poles are required in some riding areas. Check local regulations before riding.

Controls & Features

Accessory Socket

RIGHT FRONT

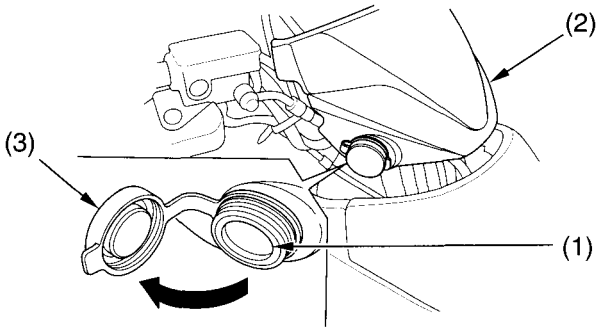

(1) accessory socket
(2) meter cover

(3) cap

The accessory socket (1) is attached to the right side of the meter cover (2). You can use the accessory socket to power a trouble light, spotlight, CB radio, or cell phone, etc.

NOTICE

Do not plug in any heat-generating accessory such as an automobile cigarette lighter because it can damage the socket.

To use the accessory socket, turn the ignition switch ON (I), start the engine. Then turn the headlights OFF (●), and open the accessory socket cap (3).

Controls & Features

Be sure the engine is on and the headlights are turned off before using the accessory socket, otherwise you may drain the battery.

The accessory socket's rated capacity is DC 12V, 120 Watts (10A) or less. If you exceed this limit, you may blow a fuse. See *If a Fuse Blows*, page 224 .

When you are done using an accessory, unplug it, and cover the socket with the cap.

Be careful not to flood this accessory socket when washing your ATV.

GPScape System (TRX680FGA only)

This section explains the GPScape navigation system. Instructions for the topics listed on this page are included.

| | |
|---|----|
| Introduction..... | 46 |
| Important Safety Information | 49 |
| System Limitations..... | 50 |
| System Start-up | 51 |
| Position Fix | 51 |
| System Failure to Display a Position Fix | 52 |
| Satellite Status | 54 |
| GPS Mode..... | 56 |
| GPS Mode Display..... | 58 |
| Waypoint Number Display | 59 |
| Direction to Waypoint Display | 60 |
| Distance to Waypoint..... | 62 |
| Basic Waypoint Selection | 63 |
| Advanced Waypoint Selection | 65 |
| Determining the Coordinates of Your Current Position..... | 69 |
| Compass Direction Indicator..... | 70 |
| Automatic Clock Adjustment..... | 72 |

Introduction

Any location on Earth may be described by two positioning coordinates. These two coordinates, measured by degrees, minutes, and seconds, are:

- latitude
- longitude

Latitudes are horizontal circles drawn around the Earth. The zero degree latitude (the equator) divides the globe into the Northern and Southern hemispheres.

LATITUDE

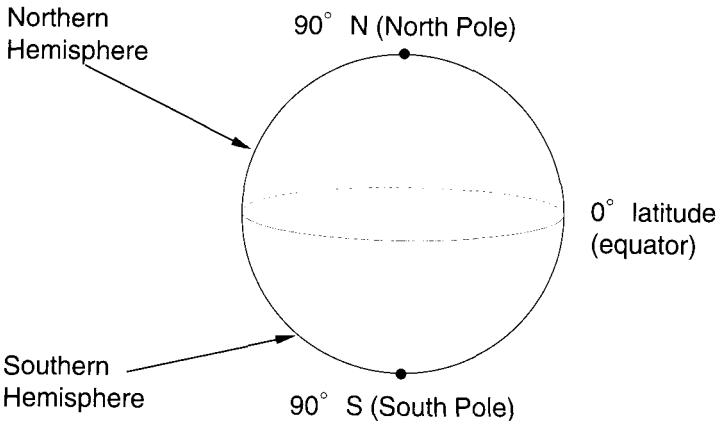

Each circle contains 360° (degree)
Each degree contains 60' (minutes)
Each minute contains 60" (seconds)

Introduction

Longitudes, also called meridians, are vertical circles extended from the North Pole to the South Pole. The zero degree longitude, which passes through Greenwich, England, divides the Earth into the Eastern and Western hemispheres. The 180 degree longitude, half way around the planet, is the international date line.

LONGITUDE

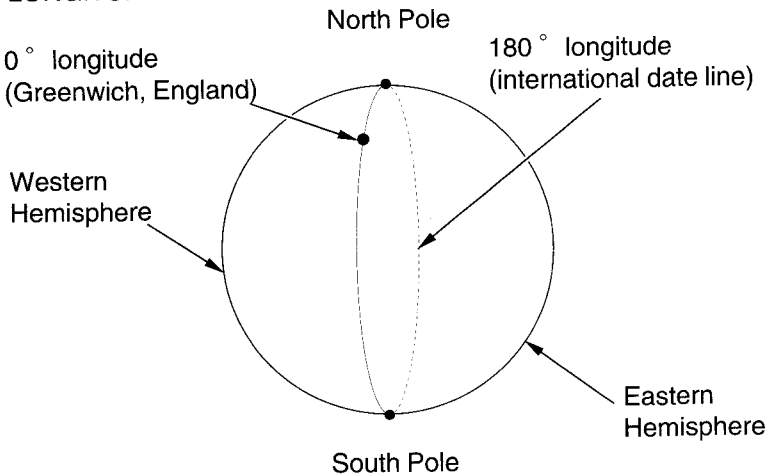

Each longitude 69 miles wide
Each time zone equals 15° longitude

Introduction

Your ATV GPScape System receives signals from the Global Positioning System (GPS), a U.S. government network that orbits the Earth, then uses those signals to calculate your current position as well as the distance and direction to other locations (destinations).

In addition to latitude and longitude, GPScape also calculates altitude (above sea level).

The primary uses of your GPScape System are:

- making your current location for future use as a waypoint (navigating position)
- inputting the latitude and longitude of a destination as a waypoint
- using the system to guide you to a waypoint

We're sure you'll enjoy using your GPScape System. It is an excellent navigation aid, but successful navigation also requires your careful attention to the terrain you are riding and your good judgment.

Important Safety Information

The GPScope System is designed to provide information to help you reach selected destinations. While this system provides the direction and distance to a destination, it does not provide an actual path. You must use your own observation of the terrain and good judgment in choosing a safe path to reach the destination.

Also, be aware that the system can distract your attention from operating your ATV if you focus too much on the display or operate the system's controls while riding. Do not look at the display unless you decide you can do so safely.

⚠ WARNING

Using the GPScope System while you are riding can take your attention away from the terrain, causing a crash in which you could be seriously injured or killed.

- Do not look at the display for more than a second or so at a time while riding.
- Stop your ATV if you need more time to look at the display or operate the system controls.

System Limitations

Your GPScape System uses signals from the Global Positioning System operated by the U.S. Department of Defense. For security reasons, certain inaccuracies are built into GPS for which your navigation system must constantly compensate. This can cause occasional positioning errors of up to several hundred feet.

Since GPScape receives information from satellites orbiting the Earth, your system's receiver requires a relatively unobstructed view of the sky. Obstructions that will limit your system's sky view include (but are not limited to) buildings, canopies, heavy rain or snow, or tree foliage.

System Start-up

Position Fix

The GPScope System uses satellite information to compute your present position (called a position fix).

Depending on the elapsed time since the ignition was last switched OFF (\circ), there are three approximate response times for the system to acquire your position fix.

| Time Elapsed Since Ignition Switched OFF | Approximate Time for System to Acquire Position Fix After Turning Ignition ON |
|---|--|
| less than 2 hours | 25 seconds |
| more than 2 hours, less than a month | 2 minutes |
| more than a month | 8 minutes |

If your ATV is transported with the ignition switch OFF (\circ) for over 60 miles (100 km) or if your ATV is not started for at least three months, we recommend that you reset your system by following the procedure on the following page, *System Failure to Display a Position Fix*.

System Start-up

System Failure to Display a Position Fix

If the receiver does not get a position fix within about 8 minutes (flashing antenna mark (1) as shown in the illustration), make sure there are no overhead obstructions (building, trees, canopy, etc.) and then perform the following:

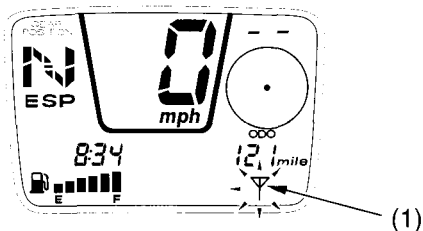

(1) antenna mark

1. Turn the ignition switch OFF (○).
2. Remove the battery cover (2) by removing the bolts (3).
3. Disconnect the negative (–) terminal lead (4) from the battery (5) and wait for 1 minute.

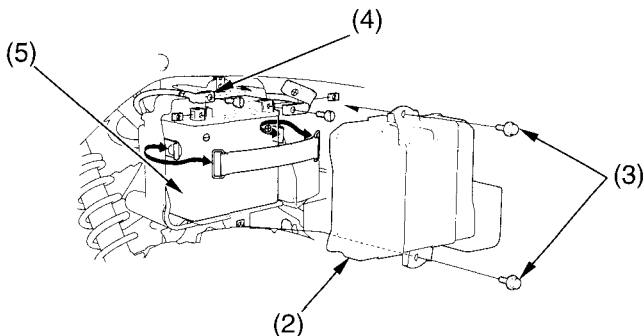

(2) battery cover
(3) bolts



(4) negative (–) terminal lead
(5) battery

System Start-up

4. Reconnect the negative (–) terminal lead and install in the reverse order of removal.
 - If you can not obtain a position fix after performing this procedure, see your Honda dealer.

Satellite Status

The satellite status indicates the amount of information received from GPS satellites in one of three possible categories:

| Display | Status | |
|---|---------------|---|
|  | Not Usable | The system is signaling (flashing antenna mark) that your position fix is not available. |
|  | 2D Navigation | The system has determined latitude and longitude, but is unable to determine altitude. 2D Navigation is not as accurate as 3D Navigation. |
|  | 3D Navigation | The system has determined latitude, longitude, and altitude. The receiver is ready to provide navigational information. |

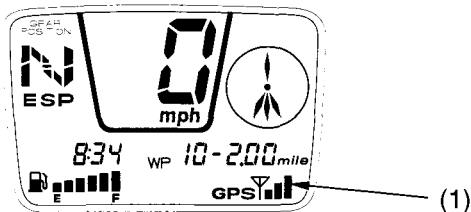

(1) satellite status (signal strength indicator)

- If there are large obstacles nearby or overhead, move to a new location with a clear view of the sky.

Satellite Status

If the GPS mark (2) blinks as shown in the illustration.
See your Honda dealer to check and restore the GPScape System.

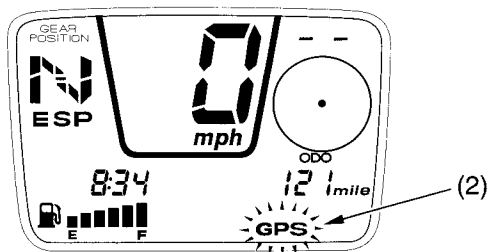

(2) GPS mark

GPS Mode

A waypoint is a geographical position (location) on the surface of the Earth. GPScape allows you to log up to 100 positions as navigational waypoints. You may then use GPScape to show you the direction of any selected waypoint, and how far you are from that waypoint via straight-line travel.

You may mark such waypoints as home, base camp, your favorite riding, fishing, or hunting spots, as well as locations of wildlife sightings. Because you have 100 waypoints available, you may mark several intersections or landmarks as waypoints during a trail ride.

GPS Mode

The GPS mode (1) shows the shortest distance to your selected waypoint. And, when your ATV is moving (one mph or faster), the GPS mode also displays an electronic arrow to indicate the direction to the selected waypoint.

Push the GPS/WP button (2) to switch between the GPS mode and the other two modes: odometer and tripmeter.

To change the display to odometer or tripmeter, press and release the odometer/tripmeter select button (3) while the display is in the GPS mode. The display will change to the previous display mode (odometer or tripmeter).

Any time you are not in the GPS mode, the compass direction indicator (4) will function while your ATV is moving (one mph or faster) (page 70).

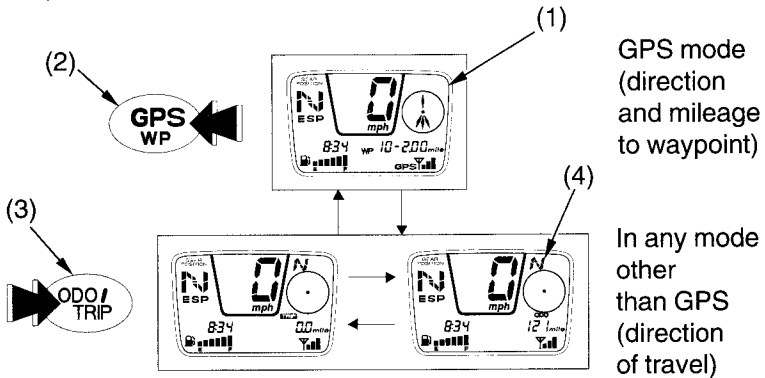

(1) GPS mode

(2) GPS/WP button

(3) odometer/tripmeter

select button

(4) compass direction indicator

GPS Mode

GPS Mode Display

The GPS mode display (1) includes the following functions:

| GPS Function | Digital Readout |
|---------------------------|--|
| waypoint number (2) | 0 – 99 |
| distance to waypoint (3) | "- - -" (3 digits for miles, and if applicable, tenths and hundredths, with a floating decimal) |
| direction to waypoint (4) |  |

The GPS mark (5) appears in the display while the GPS mode is selected. The signal strength indicator (6) appears as long as the GPS signal is active.

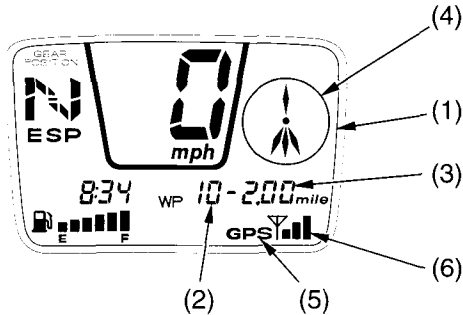

- (1) GPS mode display
- (2) waypoint number
- (3) distance to waypoint
- (4) direction to waypoint
- (5) GPS mark
- (6) signal strength indicator

GPS Mode

Waypoint Number Display

A waypoint number (1) appears in the display when the GPS mode is selected. You can store up to 100 waypoints, numbered from 0-99. To mark a waypoint, see page 63.

To select a waypoint number:

- To select a higher waypoint number, press and release the plus button (2).
- To select a lower waypoint number, press and release the minus button (3).
- To fast scroll: press and hold the plus or minus button until the desired waypoint number appears.

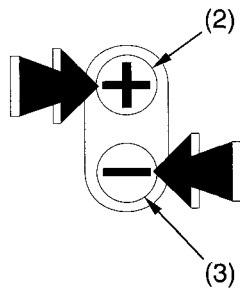
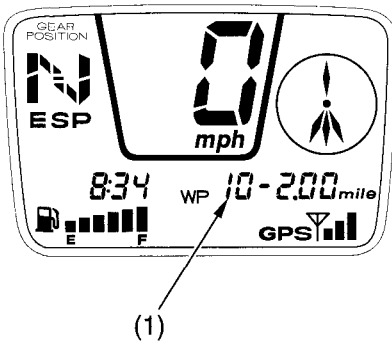

(1) waypoint number
(2) plus button

(3) minus button

GPS Mode

Direction to Waypoint Display

The direction to waypoint display (1) uses an electronic arrow to point to your destination. The display has 16 possible directions.

While operating in reverse, GPS will continue to direct you as if your ATV is still moving in a forward direction. However, the system will calculate an accurate distance and display a directional arrow to the selected waypoint.

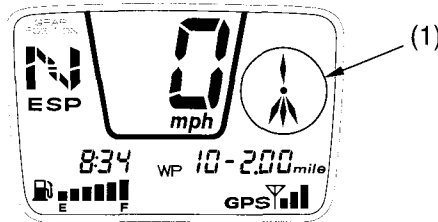

(1) direction to waypoint display

When your ATV approaches within about 16 feet of the waypoint, the direction to waypoint display will change from a directional arrow to an eight-point star (2) as shown in the illustration.

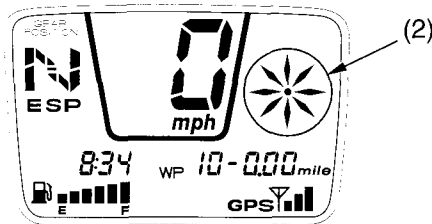

(2) eight-point star

GPS Mode

If the receiver loses a position fix (because of a large obstacle nearby or overhead), the direction to waypoint display will disappear as shown in the illustration and the antenna mark (3) will flash.

- The distance to waypoint display will continue to display the last value shown before the loss of the position fix.

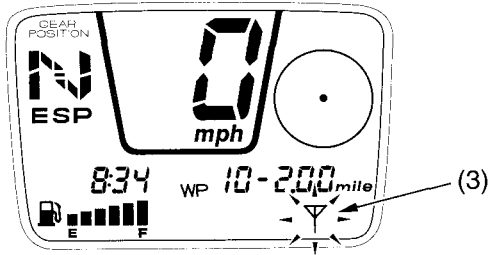

(3) antenna mark

If the receiver reacquires a position fix, the direction to waypoint display will appear as shown in the illustration.

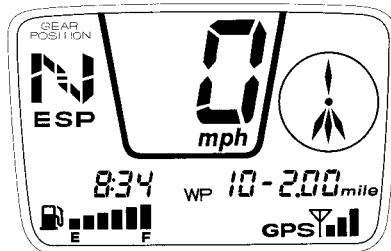

GPS Mode

Distance to Waypoint

The distance to waypoint (1) display shows the straight line distance from your present location to the waypoint.

The distance range display shows three numerals with a “floating” decimal:

| Range | Display |
|----------------------------|-------------|
| Less than 10 miles | 0.01 – 9.99 |
| 10 miles up to 1,000 miles | 10 – 999 |

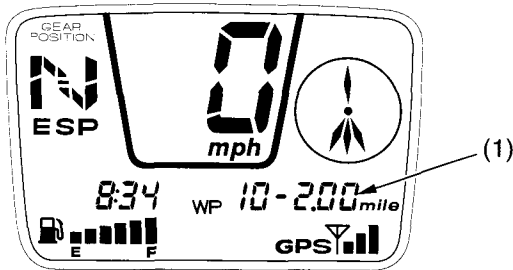

(1) distance to waypoint

GPS Mode

There are two methods for marking waypoints.

- Basic (to select your current position)
- Advanced (to input desired destinations)

Basic Waypoint Selection

To Mark Your Present Position:

1. Turn the ignition switch ON (1).
2. Use the GPS/WP button (1) to select the GPS mode.
3. To select a higher waypoint number (2), press and release the plus button (3).
To select a lower waypoint number, press and release the minus button (4).
To fast scroll, press and hold the plus or minus button until the desired waypoint number appears.
4. Press and hold the GPS/WP button (1) for about 2 seconds, until the waypoint number and distance to waypoint (5) flash. Then release the button.

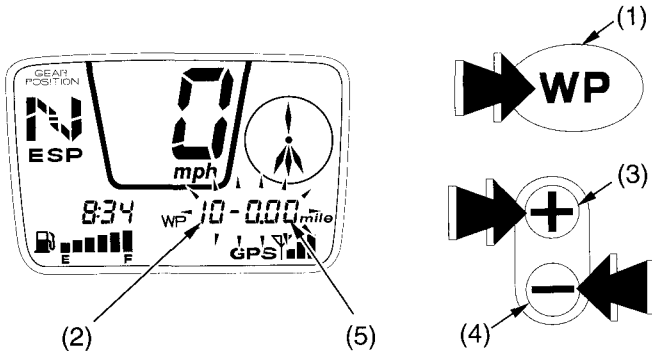

- | | |
|---------------------|--------------------------|
| (1) GPS/WP button | (4) minus button |
| (2) waypoint number | (5) distance to waypoint |
| (3) plus button | |

(cont'd)

GPS Mode

5. Within 5 seconds, to mark your present position, tap (do not hold) the GPS/WP button. (The waypoint will not be set unless the GPS/WP button is pressed a second time. Do not hold the GPS/WP button down. This will cause the system to transition to the advanced waypoint entry procedure.)

The direction to waypoint display (6) will light as shown in the illustration.

- In the 2D Navigation status, the calculated waypoint location may not be as accurate as 3D Navigation.

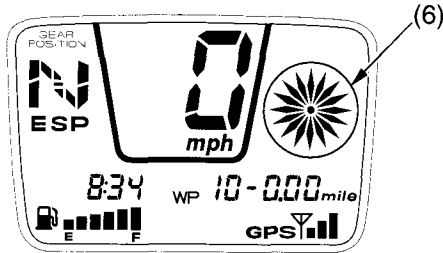

(6) direction to waypoint display

As soon as you start moving (one mph or faster), the direction to waypoint arrow will appear, pointing toward the selected waypoint location.

GPS Mode

Advanced Waypoint Selection

| Advanced Latitude & Longitude Entry Sequence | | | | | |
|--|---|---------------------------|-----------|---|---------------------------|
| latitude | 1 | --° (degrees) | longitude | 1 | ---° (degrees) |
| | 2 | --' (minutes) | | 2 | --' (minutes) |
| | 3 | -- (seconds) | | 3 | -- (seconds) |
| | 4 | .-" (tenths of second) | | 4 | .-" (tenths of second) |

To input a waypoint value using latitude and longitude coordinates:

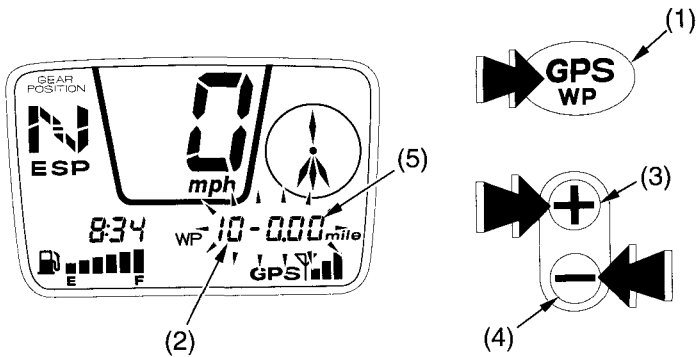

- (1) GPS/WP button
- (2) waypoint number
- (3) plus button

- (4) minus button
- (5) distance to waypoint

(cont'd)

GPS Mode

1. Turn the ignition switch ON (1).
2. Use the GPS/WP button (1) to select the GPS mode.
3. To select a higher waypoint number (2), press and release the plus button (3).
To select a lower waypoint number, press and release the minus button (4).
To fast scroll, press and hold the plus or minus button until the desired waypoint number appears.
4. Press and hold the GPS/WP button for about 2 seconds, until the waypoint number and distance to waypoint (5) flash. Then release the button.
5. While the display is still blinking, press and hold the GPS/WP button again for about 2 seconds until LAT appears above the WP mark. The compass direction indicator will flash Northern Latitude (6) or Southern Latitude (7), indicating the hemisphere. (To switch to the other hemisphere, press either the plus or minus button.)
6. Tap (do not hold) the GPS/WP button. The degree (8) will begin flashing.

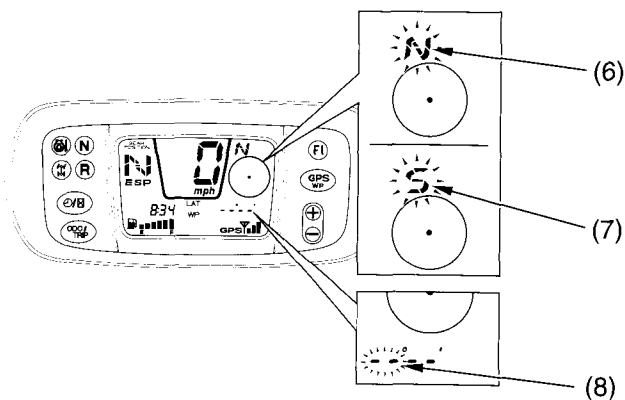

(6) Northern Latitude
(7) Southern Latitude

(8) degree

GPS Mode

7. To select your entry:

- To increase, tap the plus button.
- To decrease, tap the minus button.
- To fast change in units of 10, press and hold the plus button (to increase) or the minus button (to decrease) until the desired entry appears.

8. To enter the displayed value into the system, tap (do not hold) the GPS/WP button. The next level in the entry sequence will begin flashing.

9. To select and enter the minutes (9) — follow the same procedure used in steps 7–8.

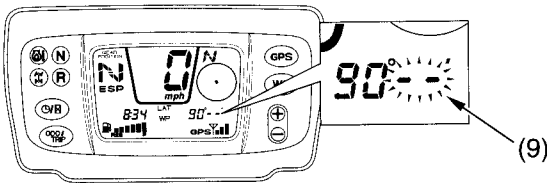

(9) minute

10. To select and enter the seconds (10) — follow the same procedure used in steps 7–8.

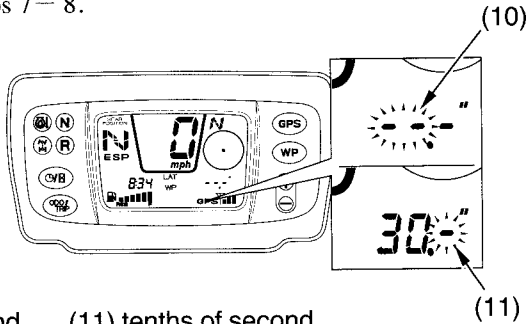

(10) second

(11) tenths of second

(11)

(cont'd)

GPS Mode

11. To select the tenths of a second (11):
 - To increase, tap the plus button.
 - To decrease, tap the minus button.
12. To enter the displayed tenths of a second in the system, tap (do not hold) the GPS/WP button until LON appears above the WP mark. The compass direction indicator will flash Eastern Longitude (12) or Western Longitude (13).
(To switch to the other hemisphere, press either the plus or minus button.)

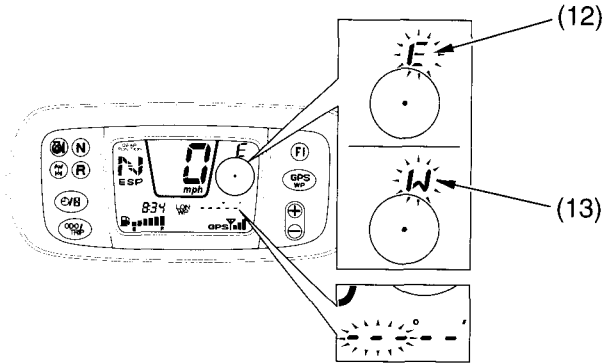

- (12) Eastern Longitude
- (13) Western Longitude

13. To enter the longitude coordinates, follow the same procedure used in steps 6 – 11 .

GPS Mode

To Correct Input:

Push the GPS/WP button (1). This reverses the sequence so you can back up and make a correction.

Once the 1/10 second longitude entry is completed, you can no longer back up in the sequence to make a correction.

To Change the Coordinates for an Existing Waypoint Number:

Follow steps 1 – 4 under *Advance Waypoint Selection* (page 65) and “overwrite” your previous waypoint.

Determining the Coordinates of Your Current Position

1. If your current position is not already marked, mark it (page 63).
2. Press and hold the GPS/WP button until the display begins blinking.
3. While the display is still blinking, press and hold the GPS/WP button again until the display shows LAT degrees and minutes.
4. Tap (do not hold) the GPS/WP button repeatedly to sequence through the coordinates display.
5. Tap the GPS/WP button again to return to the distance to waypoint display.

Compass Direction Indicator

The compass direction indicator does not appear when the system is in the GPS mode. Instead, you will see the direction to waypoint arrow — as long as your ATV is moving (one mph or faster).

The compass direction indicator (1) shows the heading of your ATV when the system is in the odometer or tripmeter mode — as long as your ATV is moving (one mph or faster). Your ATV must be moving to allow GPScope to calculate your present direction compared to your previous location.

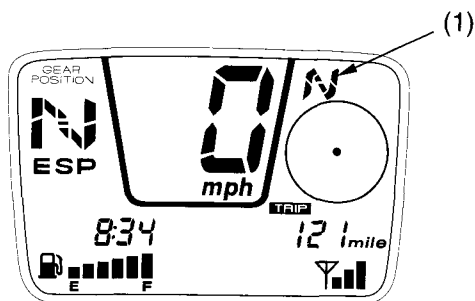

(1) compass direction indicator

The compass direction indicator displays 8 possible directions:

| | | | |
|---|-------|----|-----------|
| N | North | NW | Northwest |
| S | South | NE | Northeast |
| E | East | SW | Southwest |
| W | West | SE | Southeast |

Compass Direction Indicator

If the receiver loses a position fix (because of a large obstacle nearby or overhead), the compass direction indicator will disappear as shown in the illustration and the antenna mark (2) will flash.

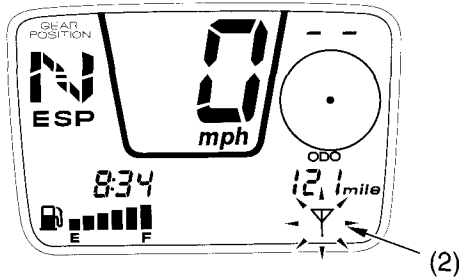

(2) antenna mark

If the receiver reacquires a position fix, the compass direction indicator will appear as shown in the illustration.

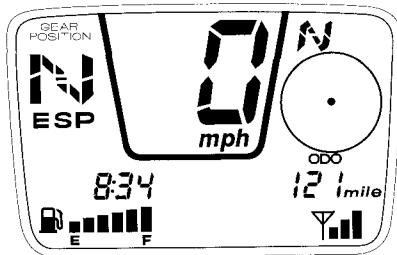

Automatic Clock Adjustment

Your ATV digital clock has an automatic adjustment function when the system's satellite status is 3D Navigation (page 54).

The system will adjust the digital clock display after receiving the basic UT (universal time, formerly referred to as Greenwich Mean Time) and then calculating your local time.

The automatic digital clock adjustment will start to function about 1 minute after your ATV's battery is connected and the initial manual clock adjustment is completed.

The automatic time adjustment should be accurate within plus-or-minus 5 minutes. To switch between standard and daylight saving time, adjust the clock manually (page 26).

Before Riding

Before each ride, you need to make sure you and your Honda are both ready to ride. To help get you prepared, this section discusses how to evaluate your riding readiness, what items you should check on your ATV, and adjustments to make for your comfort, convenience, or safety. This section also includes important information about loading.

| | |
|-------------------------------------|----|
| Are You Ready to Ride? | 74 |
| Protective Apparel..... | 74 |
| Rider Training | 76 |
| Age Recommendation | 77 |
| No Passengers | 77 |
| No Alcohol or Drugs..... | 78 |
| Is Your ATV Ready to Ride?..... | 79 |
| Pre-ride Inspection | 79 |
| Load Limits & Guidelines..... | 83 |
| Loading | 83 |
| Cargo and Trailer Information | 84 |
| Loading Guidelines | 86 |
| Accessories & Modifications | 87 |
| Accessories..... | 87 |
| Modifications | 88 |

Are You Ready to Ride?

Before you ride your ATV for the first time, we urge you to:

- Read this owner's manual and the labels on your ATV carefully.
- Make sure you understand all the safety messages.
- Know how to operate all the controls.

Before each ride, be sure:

- You feel well and are in good physical and mental condition.
- You are wearing an approved motorcycle helmet (with chin strap tightened securely), eye protection, and other protective clothing.
- You don't have any alcohol or drugs in your system.

Protective Apparel

For your safety, we strongly recommend that you always wear an approved motorcycle helmet, eye protection, boots, gloves, long pants, and a long-sleeved shirt or jacket whenever you ride.

Although complete protection is not possible, wearing proper gear can reduce the chance of injury when you ride.

Following are suggestions to help you choose the proper gear.

Helmets and Eye Protection

Your helmet is your most important piece of riding gear because it offers the best protection against head injuries. A helmet should fit your head comfortably and securely.